

()

INTERSTATE COUNCIL FOR STANDARDIZATION, METROLOGY AND CERTIFICATION
(ISC)

12,4.026—
2015



12.4.026—2015

1.0—92 «
 1.2—2009 «
 »

1 « »
 « »

2 251 «
 »

3 10 2015 . 48-2015) (

:

(ISO 3166) 004—07	(ISO 3166)004—97	
mi	am RU TJ	

4 10
 2016 614- 12.4.026—2015
 2016 .

5 12.4.026—2001

6

* () , -
1 « *
« » -
*
*
-

(www.gost.)

1	1
2	1
3	2
4	4
5	4
6	7
7	19
8	22
9	24
10	25
11	25
12	26
13	27
	()	
		28
	()	
		34
	()	
		37
	()	
		38
	()	
		40
	()	42
	()	47
	()	53
	()	56
	()	59
	()	65
	()	66
	()	67
	()	74
	75

12.4.026—2015

9.403—80

12.1.018—93

12.1.044—89 (4589—84)

12.4.040—78

427—75

7721—89

9733.3—83

()

14192—96

15140—78

15150—69

2-19—81) 17677—82 (598-1—86, 598-2-1—79, 598-2-2—79, 598-2-4—79, 598-

17925—72

18321—73

18620—86

19433—88

19822—88

20477—86

23216—78

24940—96

26824—2010

29319—92(3668—76)

30402—96

—
 («

« », « 1 », (), 1 *

3

3.1 : , /

3.2 :

3.3 :

4

4.1

4.2

4.3

-
-
-
-
-

4.4

4.5

4.6

4.7

5

5.1

5.1.1

-

	/			45-60*	-
	— 50-300	,			
	1:1	1,5:1;			
5.1.4.1)		5.1.4,)),	-
			45-60*		-
	— 50-300	,			-
5.1.4.2		5.1.4,)),		-
		45-60*			-
	— 20-300		1:1	1,5:1. ()	-
5.1.4.3					-
5.1.5		:			-
•	()				-
•	;				-
5.1.6		:			-
•	(, ,)				-
•	,				-
•	;				-
•	;				-
5.2	!				-
5.2.1				()	-
	()				-
5.2.2					-
5.2.3					-
5.2.4		5.1			-
	()				-
	()			()	-
	()				-

6.1

6.1.1

6.1.1.1

6.1.1.2

(

),
() ,

6.1.1.3

(

, —)
(,)

),

6.1.1.4

(, , , .)

6.1.2

6.1.2.1

6.1.2.2

(, , , , , mi, .).

6.1.2.3

()

6.1.2.4

().

6.1.3

6.1.4

(.1) .1), 01 (.2)
8.2

6.1.5

8 9.

6.1.6

9.

— 8.3.

6.2

6.2.1

()

6.2.2

() () ()

22 « » 23 « » (.1)

() ()

6.2.3

6.2.4

6.2.5

(20)

6.2.6

6.2.7

8.2.

6.2.8

25

()

6.2.9

(, , .) ,)

6.3

6.3.1

- ;
- ;
- ;

12.4.026—2015

-
-
-

6.3.2

2.

2—

	0		
	●		
*			
	/		
«			
<ul style="list-style-type: none"> • • <p>04 « — 01 « : * 02« 1 ».</p> <p style="text-align: right;">() » (-</p> <ul style="list-style-type: none"> • • <p>»^ 11 « — W01 « . » W02 « -</p> <p>» () ;</p> <p>— .1.</p>			

6.3.3

6.3.3.1

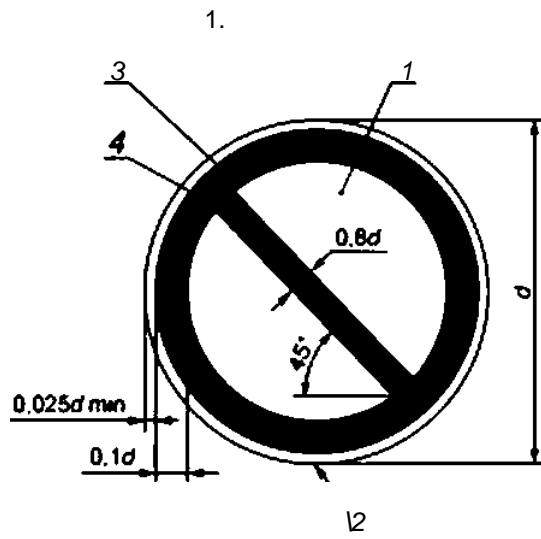

1— 2— 3— 4—

35 %

45°

6.3.3.2

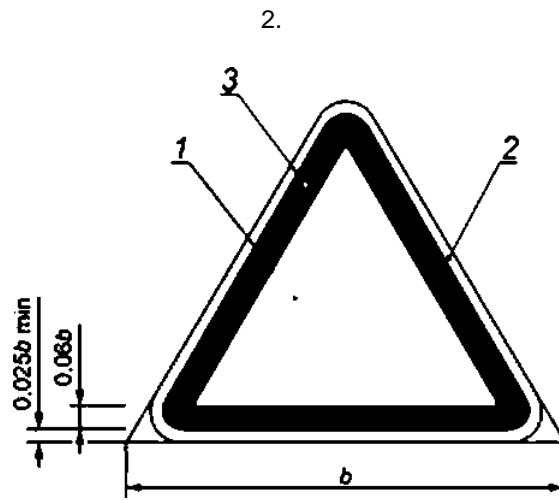

1— 2— 3—

50 %

()

6.3.3.3

3.

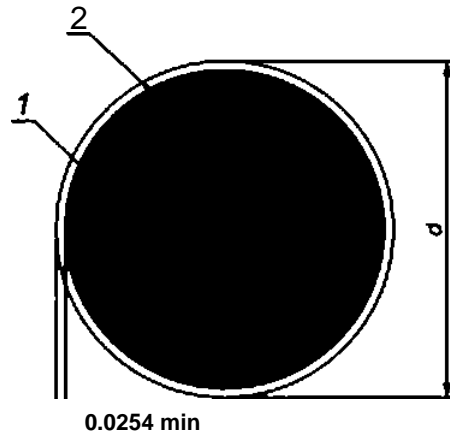

tf— ; 1— : 2—
3— iweckKo

50 %

()

6.3.3.4

4.

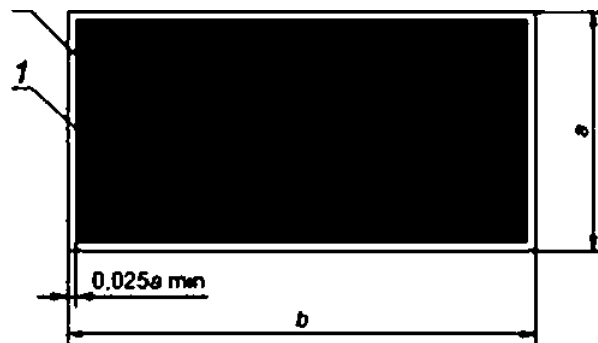
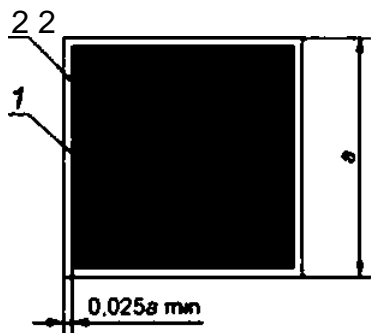

1— . 2— (2 « ;
4— 1«

50 %.

6.3.3.5

5.

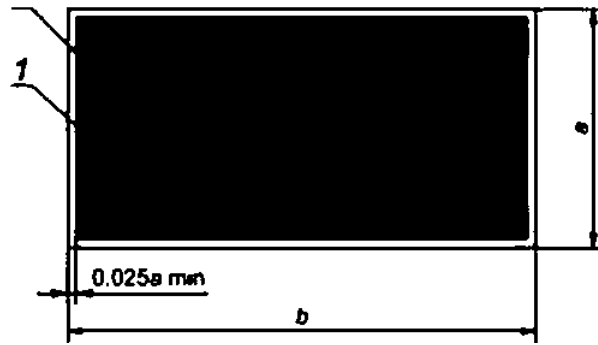
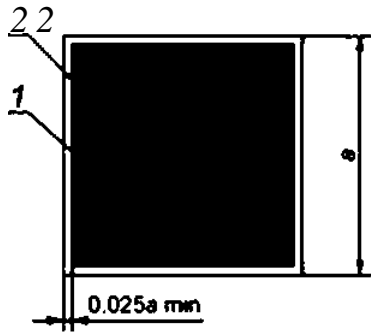

1—

(2* « tit; ; 2—

5—

50 %.

6.3.3.6

6.

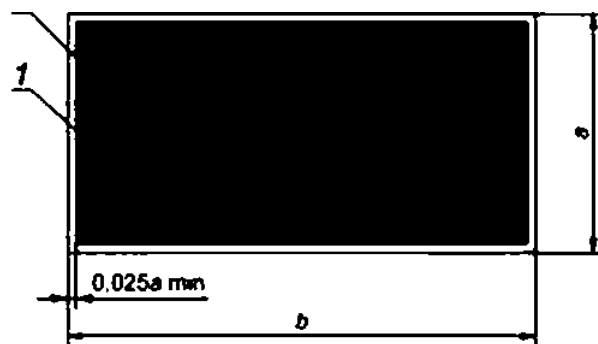
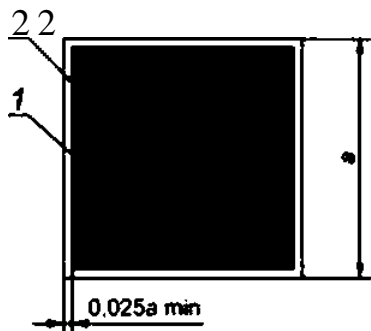

1—

(2* « tit; : 2—

6—

50 %.

6.3.37

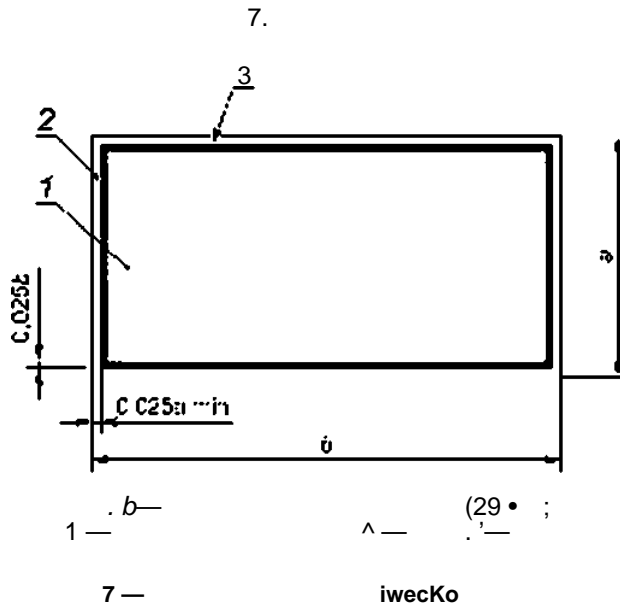

6.3.3.8

6.3.3.9

6.3.4

6.3.4.1

L —
Z —

d.

- 0,817 .

Z

- 40 —
 - 65 —
 - 25 —
- 150-300 ; 300-500 ; 30-150 .

(Z » 40)

L 25

3.

3—

U1 IVJnenHN 1	iyte		“ , , , , , ”		
1	50	50	SO	50	100
2	80	100	80	80	160
3	100	100	100	100	200
4	100	150	100	100	200
5	150	150	150	150	300
6	150	200	150	150	300
7-8	200	250	200	200	400
9-10	2S0	300	250	2S0	500
11-12	300	400	300		600
13-14	3S0	450	350	350	700
15-16	400	500	400	400	800
17-18	450	5S0	450	450	900
19-20	500	600	500	500	1000
21-22	550	700	SS0	S50	1100
23-24	600	750	600	600	1200
25	650	800	6S0	650	1300

6.3.4.2

6.3.4.3

125 %

3.

6.3.4.4

()

500 (500 / 2)

3.

12.4.026—2015

6.3.4.5

(2)

Z

L

6.3.4.6

4.

4—

	a	
1	20	25
2	30	40
3	40	50
4	60	80
5	80	100
6	120	150

6.3.4.7

! 2 %.

6.3.4.8

:

- $\wedge - 0,05 b (-)$;
- $- 0,04 < ? (< ? -)$;
- $- 0,02 (-)$.

6.3.5

6.4

6.4.1

8.

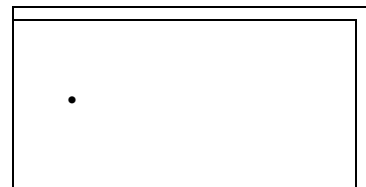

)

>

)—)

,)—

;

}—

8—

*

6.4.2

9.



Λ



ctumwiwio
liohhi ← *



9—

6.4.3

6.4.4

6.4.5

7.

(

10.



10, 1—



owl



Выход направо вниз

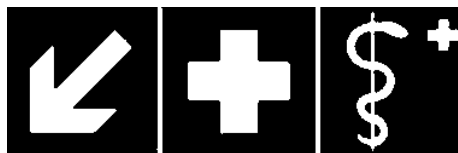

>*



* <



10. 2

6.5

«

6.5.1

6.5.2

6.5.3

• ; -
•

; , 5.2 6.3;
•
•

6.5.4 , -

6.5.5 -

12.4.040. 10 .

6.5.6 , 6.6 ,

6.6 «

6.6.1 -

(, « » «EXIT»).

6.6.2

6.6.3

6.6.4 , ,

L (3)

L— ;
Z— Z 0,7

• 300— (300-500);
• 230— (150-300);
- 120— (30-150).

6.6.5 (-
, ,), 25 % -

6.6.6 , , , -

7

7.1

7.1.1 ,

7.1.2 ,

, , , , , , , -

7.1.3 -

7.1.4

7.1.5

8 9.

1

8.3.

7.2

7.2.1

•

•

•

•

•

•

•

•

•

•

•

•

•

•

•

7.2.2

7.2.3

7.2.4

7.2.5

17925.

« », 116).

7.3

7.3.1

()

45-60*

(« »).

11.

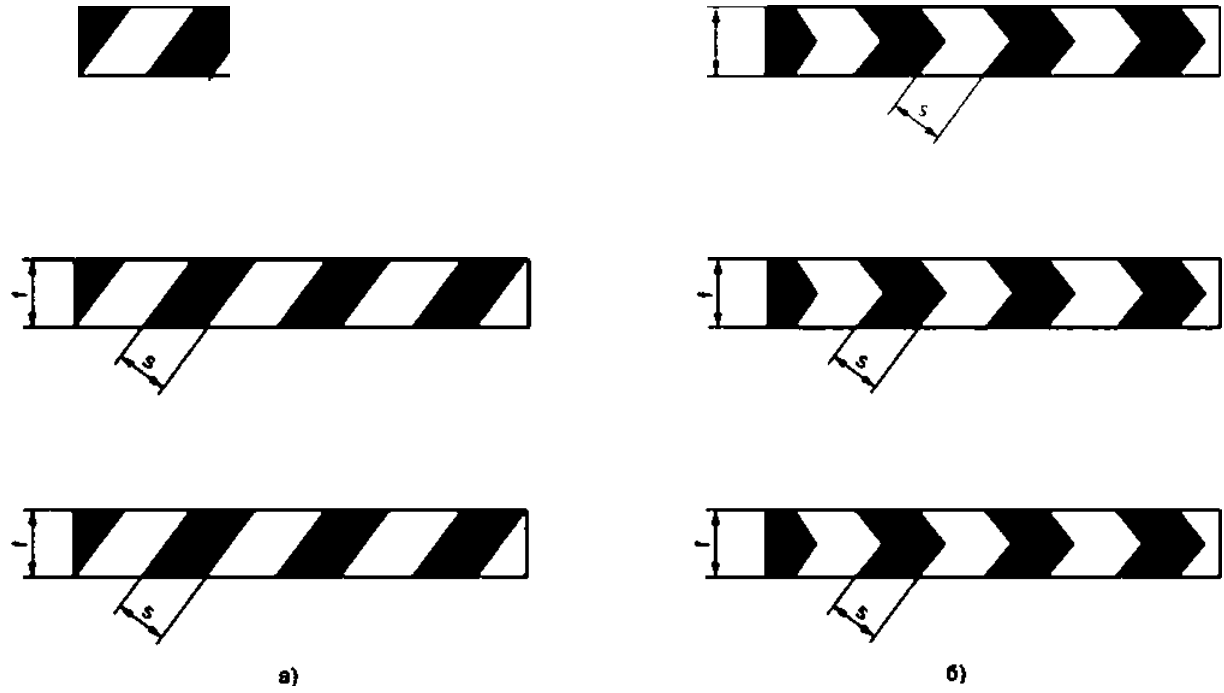

TM= ^

TM=

8)

)—)— ;)— (—). « »;
 — /

12.4.026—2015

7.3.2

50 %.

1:1 1,5:1

7.3.3

s—20-500

7.3.4

f(ui

)—

20

7.3.5

f

•

;

•

;

•

7.3.6

« f— ± 3 %.

7.3.7

», «

»

(

-

),

(

-

)

(

-

).

6.6

8

8.1

«

8.1.1

9.

8.1.2

8.1.3

8.1.4

(

).

4 %

1,5 %

8.1.5

100)

•

—

200

:

0,3

•

—

600

0,6

8.1.6

- 0,5 —

10

;

- 1,5 —

24

8.1.7

9.403.

8.1.8

(8.2.10.2).

10x10

8.2

ix

8.2.1

9.

8.2.2

8.2.3

15140 (

8.2.4

8.2.5

8.2.6

8.2.7

8.2.8

8.2.9

8.1.7.

8.2.10

8.2.10.1

5.

5 —

	10	9	
1	50	7	420
2	140	20	720

8.2.10.2

1 —

100

2 —

12.4.026—2015

100 ; , , ;

8.2.10.3 ; , , . -

8.2.10.4 . -

8.2.10.5 () () -

, , -

, , -

, , -

8.2.10.6 () -

, , -

• 10 60 (15 ± 5) % ;

• , -

8.2.10.7 () -

• ;

• ,

• ;

• - ;

8.2.10.8 () ;

, (,) , , — 5 .

8.3 «

8.3.1 () 15150 -

- (40 + 2)* (60 ± 2)* — (: 1); (4)

- (5 ± 2)* (35 ± 2)* (5 + 2)* (60 + 2)* — 98%.

8.3.2 , II () 15150.

8.3.3 (, ,), , , .

9 ,

9.1 -

9.2 -

9.2.1

9.3

• ()

-

• — — 18%;
• 2.

9.4

9.4.1

17677,

9.4.2

9.5

12.1.018.

9.6

9.7

10

10.1

10.2

11.

10.3

18321.

10.4

10.5

11

11.1

()

11.2

15140 ().

11.3

20477 (4.6).

11.4

(.)

17677.

11.5

9733.3.

12.4.1

12.4.2

12.4.3

45 60 %.
12.4.4

5 *

30 *

— 23216.

13

).

(

-

,

-

()

,
 ()
 84-107 (25 10)* 45-80 %.
 .1
 .1.1
 (.1), & .1.
 .1 — &

						&		
		1	2	3	4	1-	2-	3-
(X	0735 0285	0.681 0.239	0.579 0,341	0655 0345	> 0,07	> 0,05	> 0,03
	X	0545 0.4S4	0.494 0.426	0.444 0,476	0,481 0.518	> 0,45	> 0,27	> 0,16
	X	0201 0776	0.28S 0.441	0,170 0,364	0,028 0.399	> 0,12	> 0,04	> 0,03
	X	0094 0.125	0.172 0.198	0,210 0,160	0,137 0.038	> 0,05	> 0,01	> 0,01
	X	0350 0360	0,305 0.315	0,295 0,325	0.340 0.370	> 0,75	> 0,35	> 0,27
	X	0385 0355	0,300 0,270	0,260 0.310	0.345 0.395	—	—	—

1 , & C^s 7721. .1. 4540*,
 2 o(&- / o). & XYZ1931 .

2 —

	-												
						1>				2- 3-			
		1	2	3	4	t	2	3	4	1	2	3	4
	X	0,638 0,312	0,690 0,310	0,610 0,340	0660 0,340	0,660 0,340	0,610 0,340	0638 0312	0,690 0,310	0,660 0,340	0,610 0,340	0,700 0,250	0,735 0,265
	X	0,494 0,505	0,470 0,480	0,493 0,457	0,522 0,477	0,494 0,505	0,470 0,480	0,493 0,457	0,522 0,477	0,494 0,505	0,470 0,480	0,513 0,437	0,545 0,454
	X	0,230 0,440	0,260 0,440	0260 0,470	0,230 0,470	0,110 0,415	0,150 0,415	0,150 0,455	0,110 0,455	0,110 0,415	0,170 0,415	0,170 0,500	0,110 0,500
	X	0,140 0,140	0,160 0,140	0,160 0,160	0,140 0,160	0,130 0,086	0,160 0,086	0,160 0,120	0,130 0,120	0,130 0,090	0,160 0,090	0,160 0,140	0,1 X 0,140
	X	0,305 0,315	0335 0345	0,325 0,355	0,295 0,325	0,305 0,315	0335 0,345	0,325 0,355	0,295 0,32S	0305 0315	0,335 0,345	0,325 0,355	0,295 0,32S

45* *,
XYZ1931 .

.13 (S

.14 hi

(.1). 6 .1.

.15 .1

2 pact

,2.1 /^

		^
		5 < < 1S
		5 < * < 15
		5 < < 15

.2.2

:

1 - () . ;
 2- . ;
 1- , 2- ;
 341 . 3- () ,
 ||| , 3-
 .23 ^ R' .4 — .7.
 .4

	&	1- R' / (2)				
0.2*	—4*/5*	70	50	14.5	4	9.0
	30*	30	22		17	3.5
	40*	10	7	2	05	1.5
0,33*	-4V5*	50	35	10	2	7
	30*	24	16	4	1	3
	40*	9	6	1,8	0.4	1.2
2.0*	—4*/5*	5	3	0,8	02	0.6
	30*	2.5	15	0.4	0,1	0.3
	40*	1.S	1JD	0.3	0,06	0,2

AS

		2- R' / (2)				
0,2*	—4V5*	250	170	45	20	45
	30*	150	100	25	11	2S
	40*	110	70	16	8	16
0,33*	-4*/5*	180	122	25	14	21
	30*	100	67	14	7	11
	40*	95	64	13	7	11
2.0*	-4V5*	5	3	05	0.2	0.6
	30*	2.5	1.5	0.4	0.1	.
	40*	1.5	1	03	0J06	0.2

6

	R' 3(A). *(2}											
	0.1*.				02*.				0,33*.			
	5*	20*	30*	40*	5*	20*	30*	40*	5*	20*	30*	40'
	850	600	42S	275	625	450	325	200	42S	300	225	ISO
	550	390	275	175	400	290	210	130	275	195	145	95
	170	120	8S	55	125	90	65	40	8S	60	45	30
	85	60	40	25	60	45	30	20	40	30	20	15
	55	40	28	18	40	30	20	13	28	20	15	10

— «0,33* • 5* (Pj» 0*) 2,5:1
 t > 75* 50* 25*.

.7

	14 R' 3(), /(2}											
	033'.				I*,				15*.			
	S'	20*	30*	40*	S*	20*	30'	40'	S'	20'	30'	40*
	300	240	16S	30	35	30	20	35	15	13	9	1.5
	195	155	110	20	23	20	13	2	10	8	6	1
(60	48	33	6	7	6	4	1	3	2,5	2	0.5
	30	24	17	3	35	3	2	05	1.S	1	0.5	—
	19	16	11	2	25	2	1.5	05	1	0.5	0.5	—

1 -0,33* , • 5*(I^» 0*) 2,5:1

2 75* 50* 2S*.

.2.4

R* 7721,

.2.5

R' 80% , .4— .7.

.2.6

1-

.4.

SO % ,

.2.7

2-

A.S.

50 % ,

.2.8

3-

6 .7.

SO %

.2.9

(

),

13

2).

,

» 1.S*.

, «-86.5*.

0*

» *.

()

,
:

.1
4S-80 %.
84-107 (630-800 . .).
(25* 10) ^.
()

.2
.2.1
:
2 01931 .;
. . D65;
45 ,
: X» 0,8-109,8,
.08—100,0,
2* 0,8-118.2;
» 0,100-0,735,
» 0,100-0,834;
:
* * AZ* 1,0,
» « 0,01.

.3.1 ()
D6S (7721) .4. 4570*(),
1931.
)*-

.3.2 ,
(.1), .1.
.1 — ,

		1	2	3	4
(X	0,735 0,265	0,681 0,239	0579 0341	0,655 0,345
	X	0,545 0,454	0,494 0,426	0,444 0,476	0,481 0,518
	X V	0,201 0,776	0,28S 0,441	0,170 0364	0,026 0,399
	X V	0,094 0,125	0,172 0,198	0210 0,160	0,137 0,038

(-)

.2 —

	-				
		1	2	3	4
((-))	X	0,690 0,310	0,595 0,315	0,535 0,375	0,610 0,390
-	X	0,390 0,410	0,320 0,340	0,320 0,410	

4540*.
XY21931 .

— ,

D65

.1
7721.

.2,

()

.1

.1

1«(»«) -

.1.3.

.1 —

	(4000 (1)) (- (6J	RAL(2)	(3	« » (4))
	1.6 2/2	11*	RAL3020	7.5 R 4/14	—	Pantone Waim Red
	—	220	RAL 1023*	5 Y 8.5/14	22-3*	Pantone 109
	7.5 2/2	385	RAL6024*	5 G 4/8	—	Pantone 3415
	12 4/2	—	RAL5005	2.5 3/10	03-6	Pantone 301
	—	—	RAL9003	95	—	—
	2/8	800	RAL9004	1	37-7	—

— «*»

) .1 2).

()

»*

*

.1
.1.1

- , , 1,0-20000; , % , 6,0; .%
• 2,0;
• 6 ;
• , ' 0-40.

.1.2

()
: 10
• 60 — (200-230) / 2;
- 1440 —(25-35) / 2—
7.6.

.2
2.1

24940. -

2.20

(7.8) () -

2.3

(7.5),
, 10x10
, () 15
() 15 ()

() .

()

1440

()

()

45-80 %.

84-107

(630-800

.)

(25 ± 10) 12 .

.1

1.5

24 .

.2

.2.1

1.0-20000;

,%, 2 ;
,%.

2,0;

* . 0-40;

.2.2

8.332.

1 / 2,
0,001-20000;

,%. 5 ;

60;
. %.

2.0;

* . 0-40;

()

65

7721

150-500 .

(1000 25) .

()

		(1000 £ 25) ,		
		1.1.		
.4				-
.4.1				-
	24940.			
		.2.1.		
.4.2			26824	-
			.2.2.	
.4.3				
.4.3.1		()	-
			.1.	(
	.2.3	15),
				2,10
60				
	.4.3.2			
.4	1440	(24)	-
	0,3	2,		/ «
1440	».			
.4.3.3				-
			2(-
	0,6	2).		
				1440 mih
		0.3	/ 2.	180
				/ 2.
.4.3.4				
	.4	.1.	(
(

.1

()

05

N

<

06

i

N

()

()

JL

07



()



()



Запрещается прикасаться. Корпус под напряжением

.1

()

10



!

,

-

11



()

-

-

12



(

-

,

,

,

-

13



()

-

(

-

)

14



()

.

.

.

...

,

-

()

.1

			()
16		- () -	-
17		-	-
18		- () -	- , , , -
21		() -	- , -
27		() (.)	- , -

.1

U

()

30



-

, ,

-

32



-

!*

*

*

,

-



Запрещается брать руками. Сыпучая масса (непрочная упаковка)

,

*

-

34



-

*

fp

-

)

(

,

«

»

()

\$ <

1

			> ()
W01		.	/ - - ,
WD2			, - . , - .
		.	, ,
W04		.	, ,
W05		.	, , 1 - - 17925

.1

			()
W06		.	. 1 , , . .
WD7		l* «1 . *	-, (-
W08		-	, , - , ,
W09		. ()	/ ,
W10	/	.	., (, -

.1

			^ ()
W11		.	.
W12		.	;- ;
W13		.	;- .
W14		.-	;- .
W15		.-	.

.1

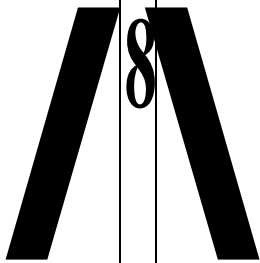
			()
W16		()	,
W17		.	<
W18		()	,
W19			()
W20		.	»

.1

			()
W22		.	, / , 6 6 , . -
W23		. 1«/	*
W24		. *	, . , , - -
W25		. () *	, -
W26		.	,

.1

			()
W27		.	, ' -
W28		.	, -
W29		.	> Hanpit/ep. -
W30		.	, ' () , -

(1)

.1

01



()

il,

sa-

02

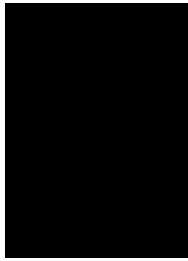

()

pe6o4ix





M0S



1 1

iwo

. 1

			()
06		-	. - ,
07			,
08		-	^ . -
09) (-	() . -
10			, -

.1

()

11



1
11,1*1
()

12

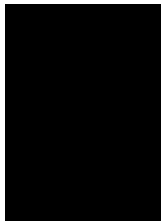

13

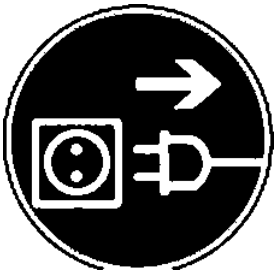

14



M1S



()

.1

()

F 01-01



()



Направляющая
стрелка под углом
45°

()

F02

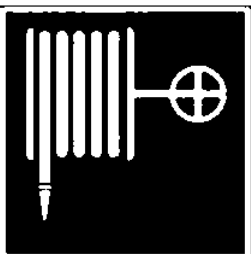

Пожарный кран

/

F03



.1

()

F04



F05



F06

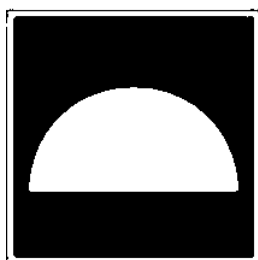

Место размещения
нескольких средств
противопожарной
защиты)

F07



F08



(1)

.1—

01-01



01-02



02-01



02-02



45*



. 1

()

04



-

-

E0S



-

-

06



-

-

07



-

-

08

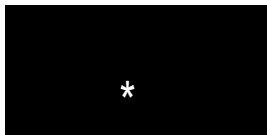

-

-

09



-

-

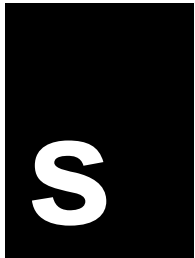

()

-

11



-

, ,

-

.1

()

12



- ' , ' -

13



- ' -

14



- hep ' -

E1S



- hep ' -

16



- ' -

17



' , ' -

.1

()

18

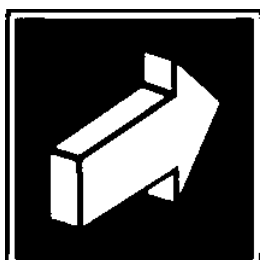

-

-

19



-

-

m

E20

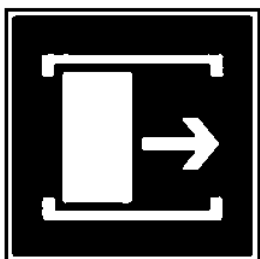

Для открывания
сдвинуть

1«

-

21

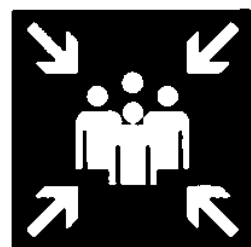

< ()

()

*

-

E22



Указатель выхода

-

1-

23

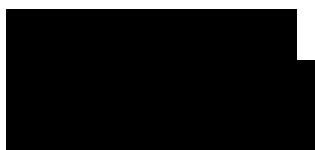

-

.1
2
01-02

01-01

2—

()

01

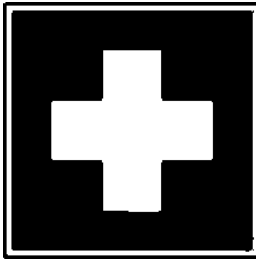

02

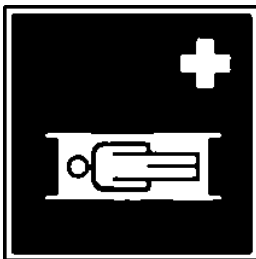

()

()

04



EC0S

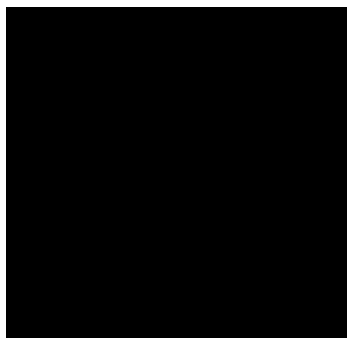

.2

				(
06			. - () -	

()

.1

			()
D01	EQ	() -	(, , - , ,
D02			(, , - , . .)
D03			

()

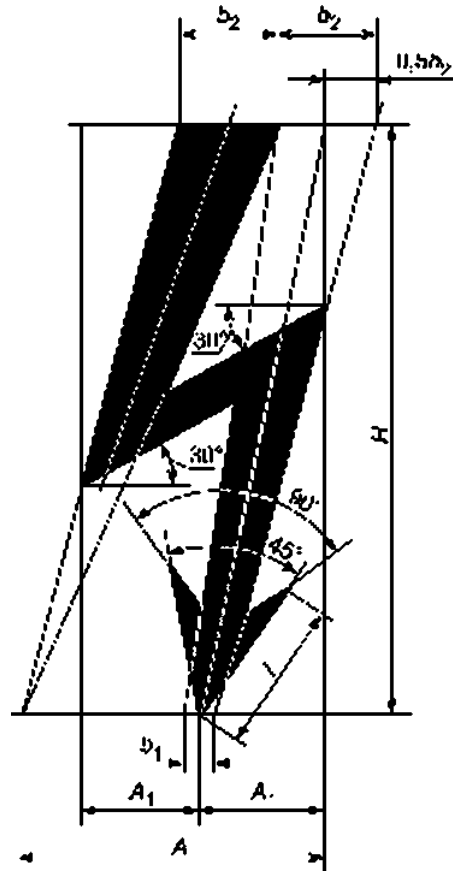

.1—

.1

6—1000

- 0.5 ;
- 0.2 ;
- 6, • 0.04 ;
- /° 0.25 ;
- 2» 0.16 .
- 2

W08 ()

.4

(6 * !)



Рисунок П.1 — Запрещающие знаки



W01

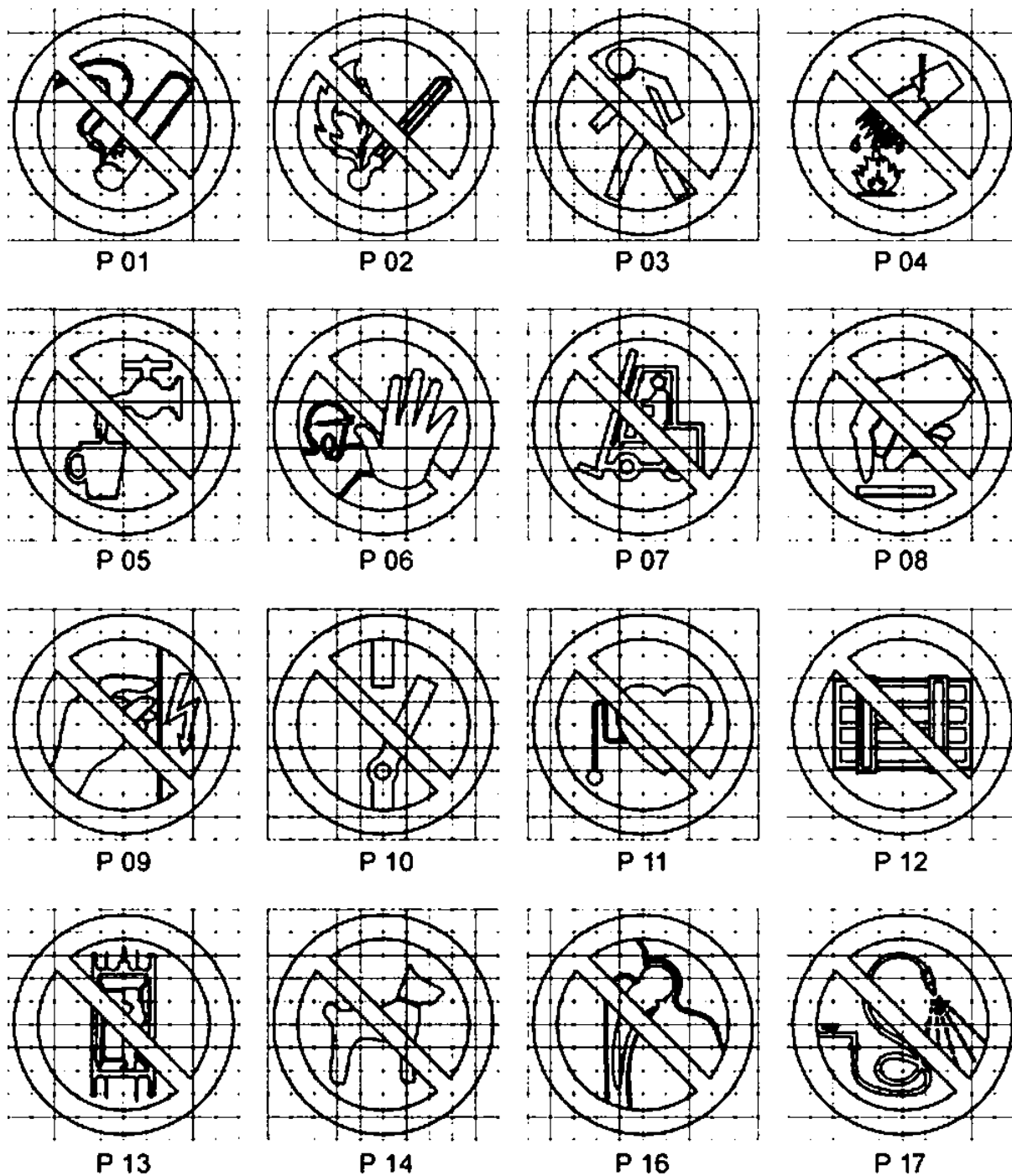
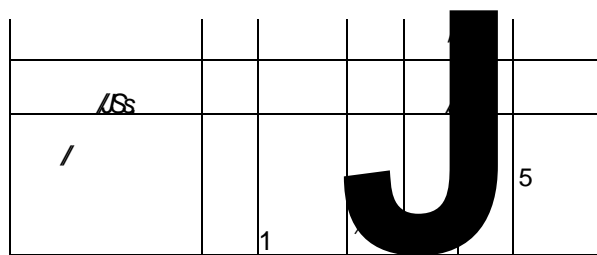
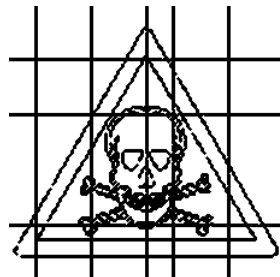

W03

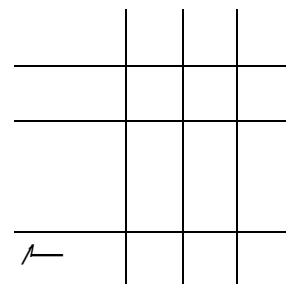

W04

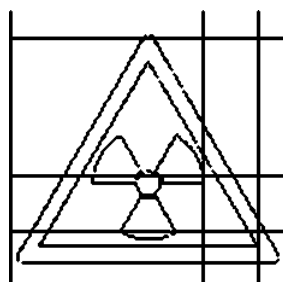

W05

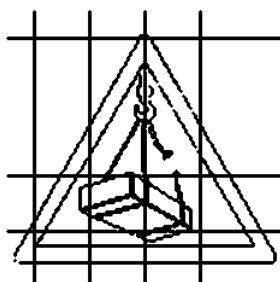

W06

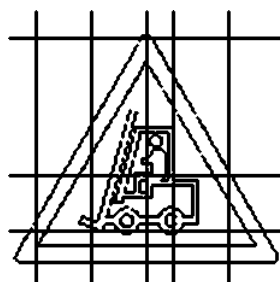

W07

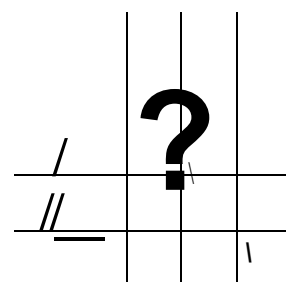

W08

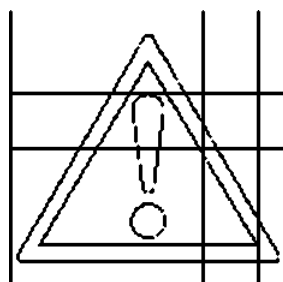

W09

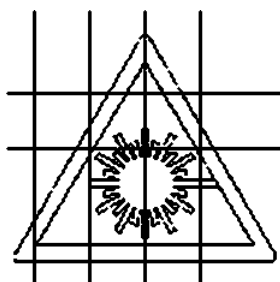

W10

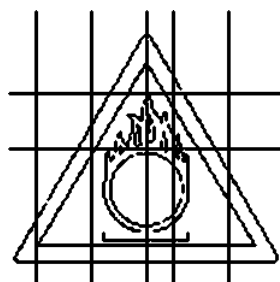

W11

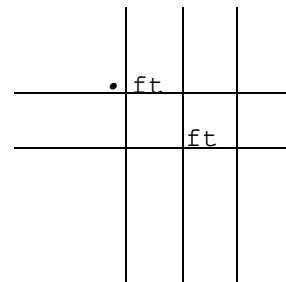

W12

Рисунок П.2, лист 1 —

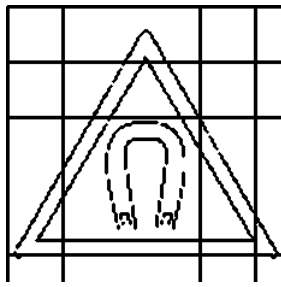

W13

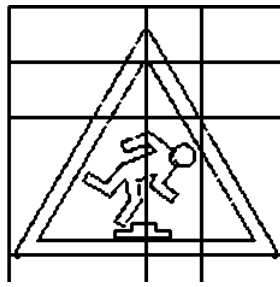

W 14

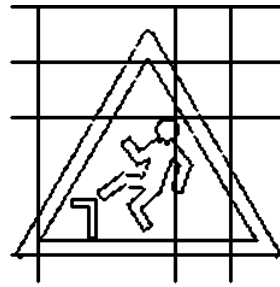

W 15

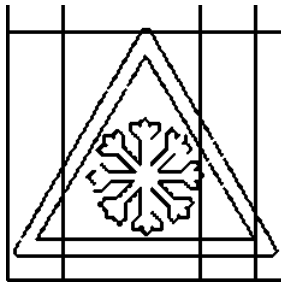
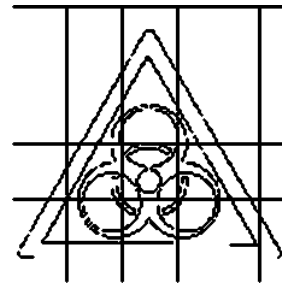

W 17

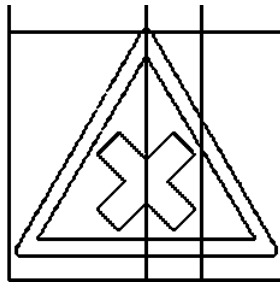

W 18

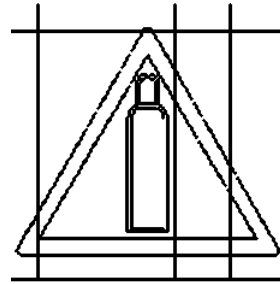

W 19

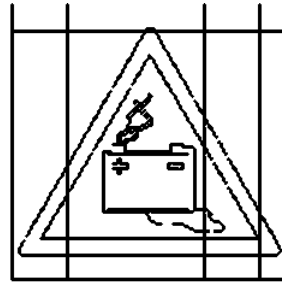

W 20

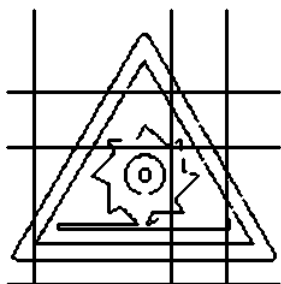

W 22

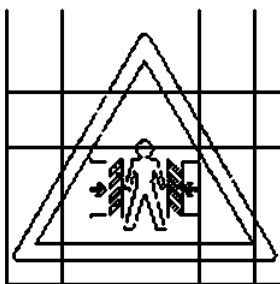

W 23

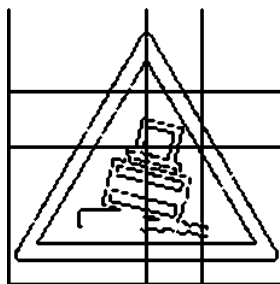

W 24

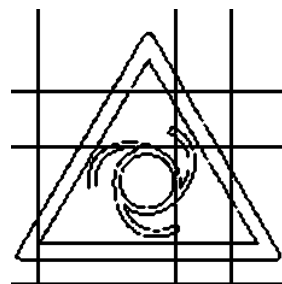

W 25

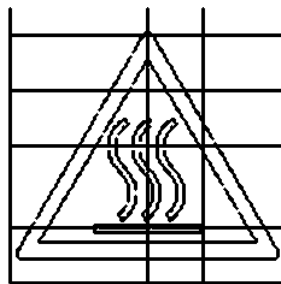

W 26

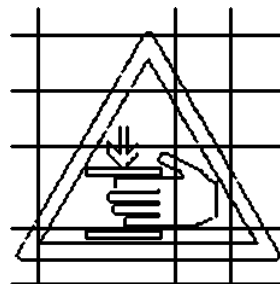

W 27

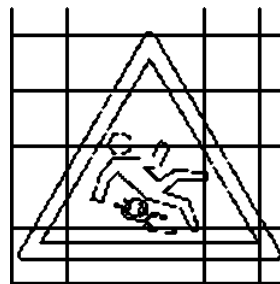

W 28

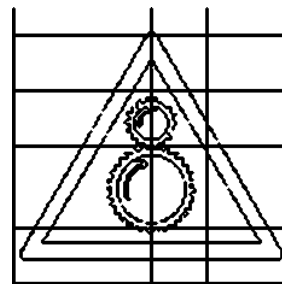

W 29

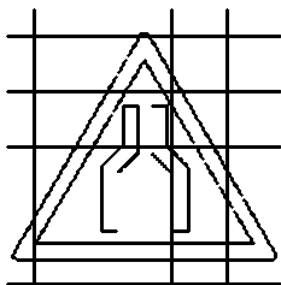

W30



Рисунок П.3 — Предписывающие знаки



F 01-01

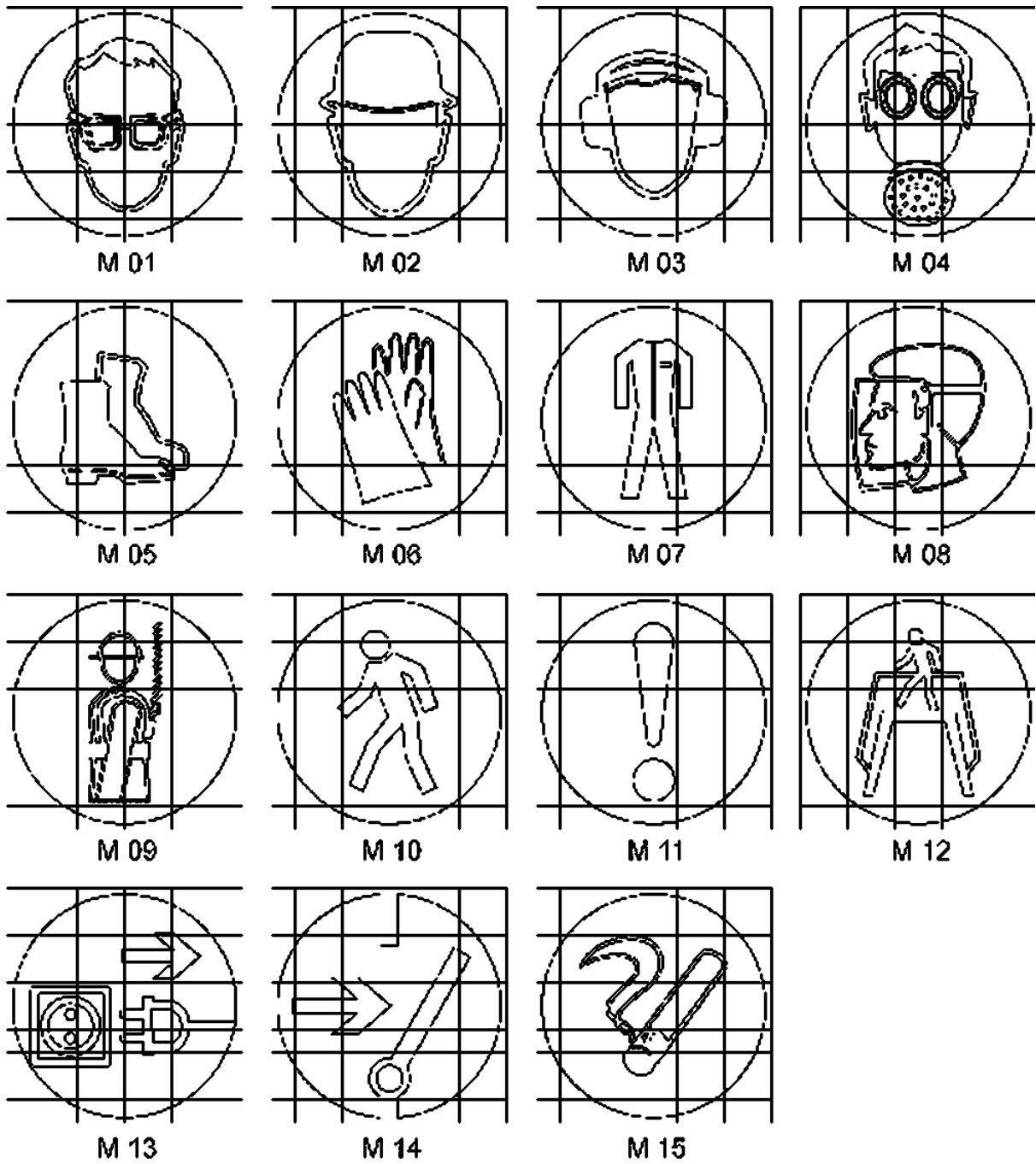
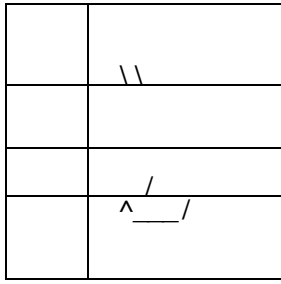
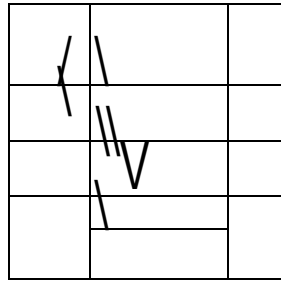

F 01-02

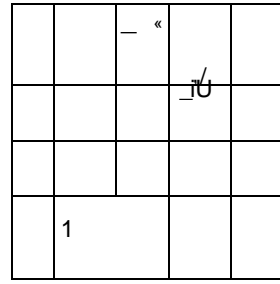

F 02

F03

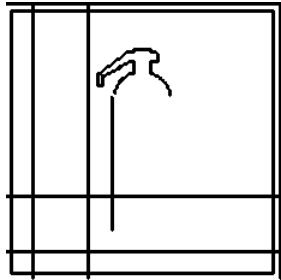

F 04

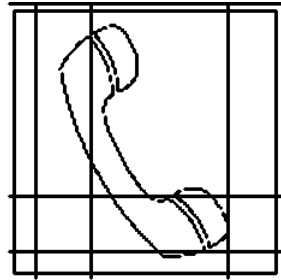

F 05

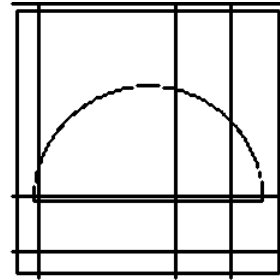

F 06

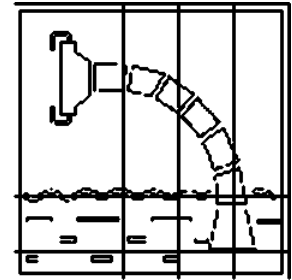

F 07

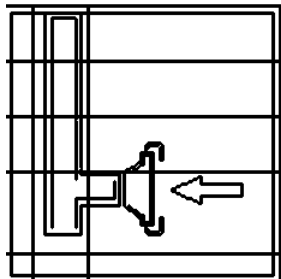

F 08

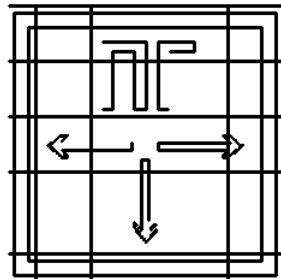

F 09

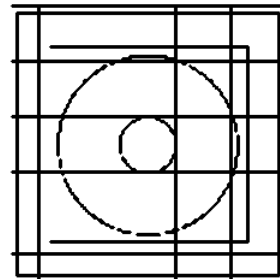

F 10

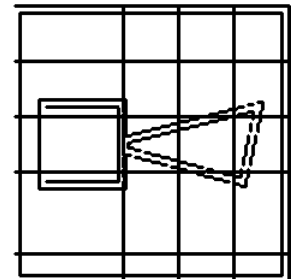

F 11

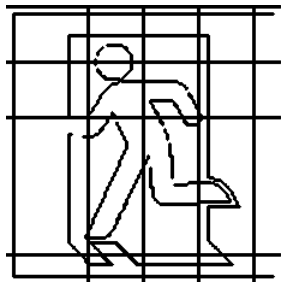

01-01

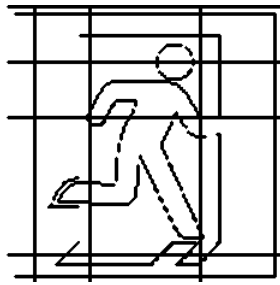

01-02

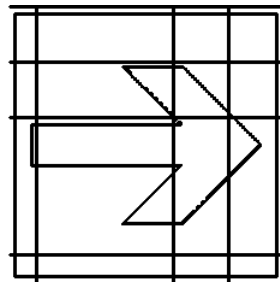

02-01

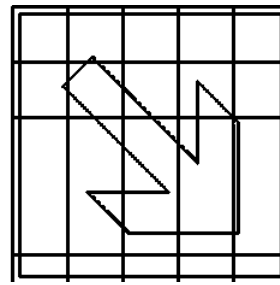

02-02

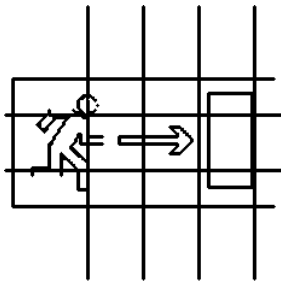

E 03

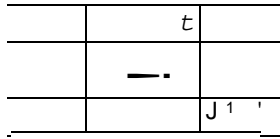

04

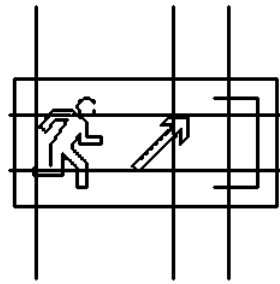

E 05

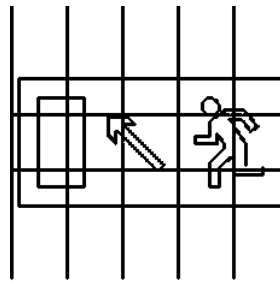

E 06

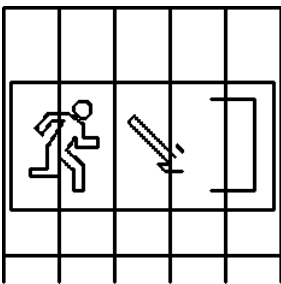

07

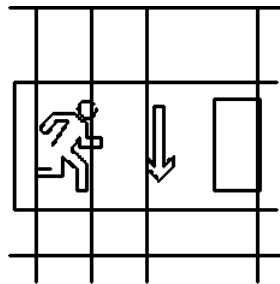
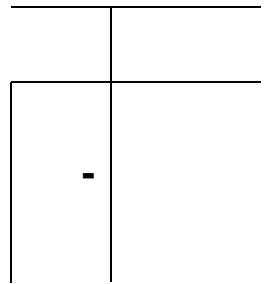

E 09

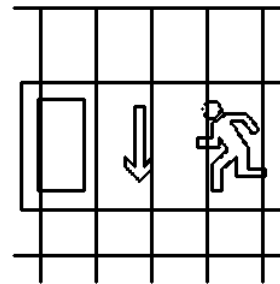

E 10

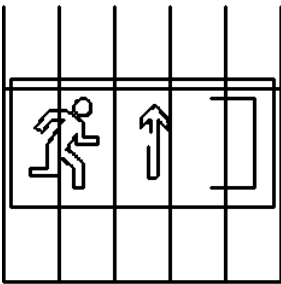

E 11

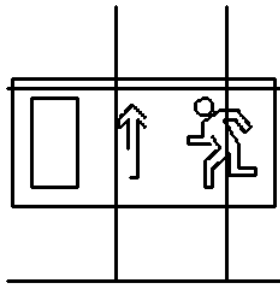

E 12

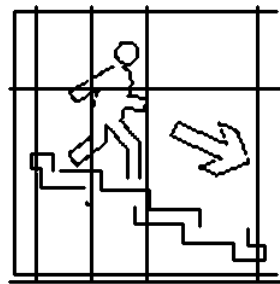

E 13

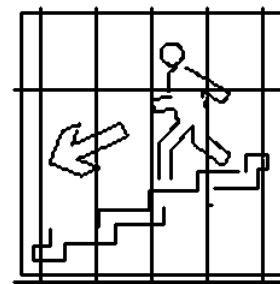

14

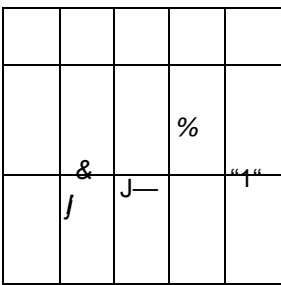

15

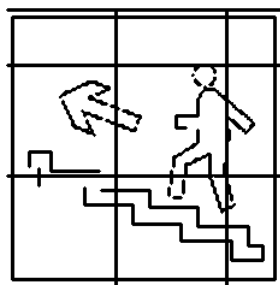

16

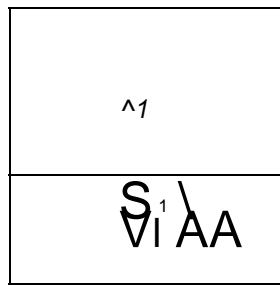

17

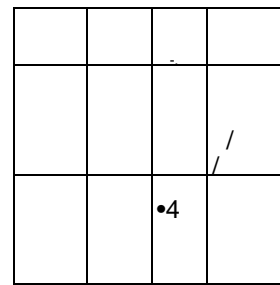

18

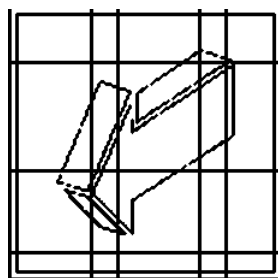

E 19

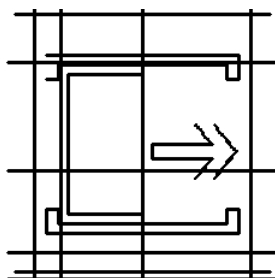

20

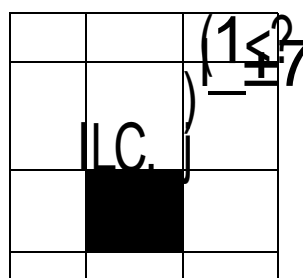

21

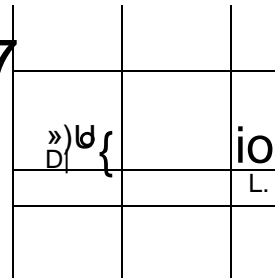

22

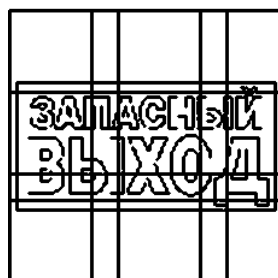

23

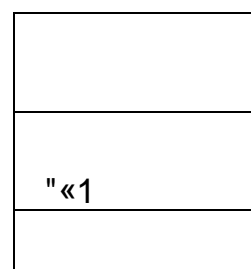

01

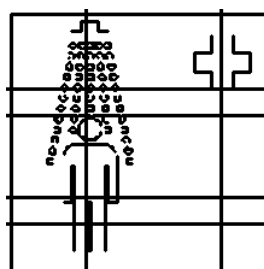

EC 03

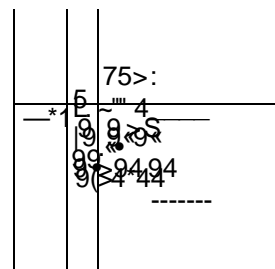

04

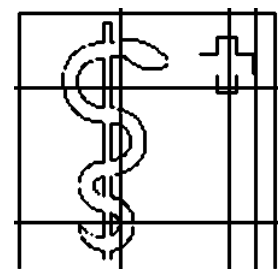

EC 05

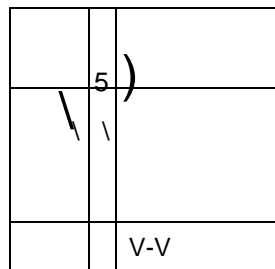

06

5. 2—

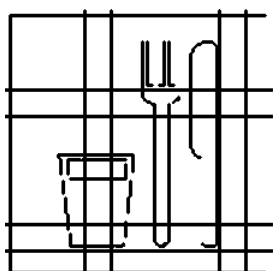

D 01

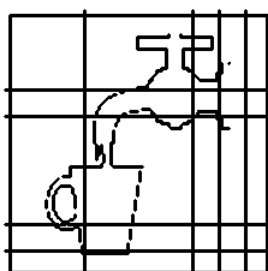

D 02

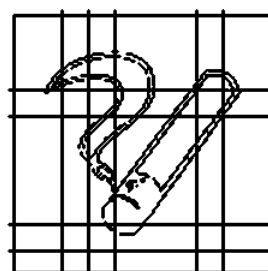

D 03

Рисунок П.6 — Указательные знаки

()

.1 « .1.

*: I—IO 1 II II 1/ // QV LJV7 *

— t

.1—

.2
.1.

.1

		10
1	(7/7)	10
2	(5/7)	7
3	(1/7)	1,4
4 ()	(11/7) W	150
5	(3/7) '	4,2
6 d	(1/7)	1,4
/ ^ 21		-
" 2/7		

- [1] () -1000.
- 1962 [2] RAL. (RAL Standards. Color Collection RAL),
- [3] (Munsell Book of color), . 1976
- [4] « ». . 1961
- [5] Pantone (PANTONE. Color fbrmiJa Guide 1000. Korp. Pantone. New Jersey). . 1995
- [6] 6*10-1449 ()

